

komet | Twin 101 ULTRA

Available Models / Modelos disponibles

Twin 101
24° / 21°



Twin 101
VARI ANGLE



Twin 101
PIVOT 18°

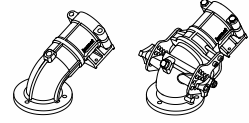

Fixed Trajectory 24° / 21° / 18°
Trayectoria fija 24° / 21° / 18°

Variable Trajectory 15° - 45°
Trayectoria regulable 15° - 45°



Large barrel cross section
Sección transversal del tubo grande

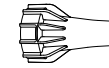

17 Nozzles
17 Boquillas
Ø 12-28 mm / 0.47"-1.10"



Dynamic Jet-Breaker (Optional)
Rompe-chorro dinámico (Opcional)

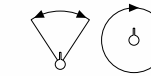

Part and full circle model
Modelo círculo parcial y completo

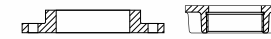

Flange: External Ø168 mm (6 39/64"), 6 holes Ø10.5 mm (13/32") on pitch circle Ø130 mm (5 1/8") and 6 holes Ø10.5 mm (13/32") on pitch circle Ø146 mm (5 3/4")
Brida: exterior Ø168mm (6 39/64"), 6 perforaciones Ø10.5 mm (13/32") en el círculo de agujeros Ø130 mm (5 1/8") y 6 perforaciones Ø10.5 mm (13/32") en el círculo de agujeros Ø146 mm (5 3/4")

Thread 2" FBSP or FNPT (Optional)
Rosca hembra 2" BSP oder NPT (Optional)

Dimensions / Medidas **24°**

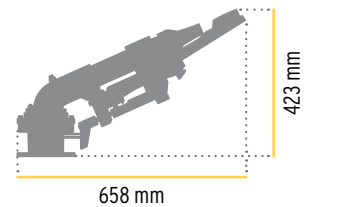

komet | Twin 101 ULTRA

Pressure Presión	Nozzle / Boquilla 12 mm - 0.47"		Nozzle / Boquilla 14 mm - 0.55"		Nozzle / Boquilla 16 mm - 0.63"	
	Flow Caudal m³/h	Radius Radio m	Flow Caudal m³/h	Radius Radio m	Flow Caudal m³/h	Radius Radio m
2,0	7,8	24,2	10,6	26,5	13,8	28,9
2,5	8,7	26,8	11,9	29,0	15,4	31,3
3,0	9,6	29,4	13,0	31,6	16,9	33,7
3,5	10,3	31,2	14,1	33,3	18,2	35,5
4,0	11,1	32,9	15,1	35,1	19,5	37,3
4,5	11,7	33,9	16,0	36,2	20,7	38,6
5,0	12,4	34,8	16,8	37,3	21,8	39,8
5,5	13,0	35,7	17,7	38,4	22,9	41,1
6,0	13,5	36,6	18,4	39,5	23,9	42,4
6,5	14,1	37,4	19,2	40,4	24,9	43,3
7,0	14,6	38,2	19,9	41,2	25,8	44,2

High Performance Nozzles / Boquillas de alto rendimiento Trajectory angle / Angulo de trayectoria **24°**

Nozzle / Boquilla 18 mm - 0.71"		Nozzle / Boquilla 20 mm - 0.79"		Nozzle / Boquilla 22 mm - 0.87"		Nozzle / Boquilla 24 mm - 0.94"		Nozzle / Boquilla 26 mm - 1.02"		Nozzle / Boquilla 28 mm - 1.10"	
Flow Caudal m³/h	Radius Radio m	Flow Caudal m³/h	Radius Radio m	Flow Caudal m³/h	Radius Radio m	Flow Caudal m³/h	Radius Radio m	Flow Caudal m³/h	Radius Radio m	Flow Caudal m³/h	Radius Radio m
17,5	29,1	21,7	29,4	26,1	29,8	31,1	30,2	36,7	30,6	42,3	30,9
19,5	32,5	24,2	33,8	29,2	34,4	34,7	35,1	41,0	35,8	47,3	36,5
21,4	35,9	26,5	38,2	31,9	39,1	38,0	39,9	44,9	41,0	51,8	42,1
23,1	37,9	28,7	40,4	34,5	41,6	41,1	42,9	48,5	44,4	56,0	45,9
24,7	39,9	30,7	42,5	36,9	44,2	43,9	45,8	51,8	47,8	59,8	49,7
26,2	41,2	32,5	43,9	39,1	45,7	46,6	47,6	55,0	49,8	63,5	52,0
27,6	42,5	34,3	45,2	41,2	47,3	49,1	49,3	58,0	51,8	66,9	54,3
29,0	43,8	35,9	46,5	43,2	48,7	51,5	50,9	60,8	53,5	70,2	56,2
30,3	45,0	37,5	47,7	45,2	50,1	53,8	52,5	63,5	55,3	73,3	58,1
31,5	46,0	39,1	48,7	47,0	51,2	56,0	53,7	66,1	56,5	76,3	59,3
32,7	46,9	40,6	49,7	48,8	52,3	58,1	54,9	68,6	57,7	79,2	60,6

P.S. The performance data were obtained under ideal testing conditions and may be adversely affected by wind and other factors. Pressure refers to pressure at nozzle. A lowered trajectory angle improves the irrigation efficiency in windy conditions. For every 3° drop of the trajectory angle the throw is reduced by approx. 3 to 4%.
Los datos indicados en la tabla se refieren a condiciones de calma y pueden ser influenciados negativamente por viento u otros factores. La presión efectiva indicada se refiere a la presión de la boquilla. El bajar el ángulo de la trayectoria, ayuda a mejorar la eficacia del riego en condiciones de viento. Por cada 3° que se baje el ángulo de trayectoria, el alcance del chorro se reduce aproximadamente entre un 3 y un 4%

komet | Twin 140 ULTRA

Available Models / Modelos disponibles

Twin 140

24° / 21°



Twin 140

VARI ANGLE

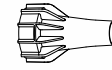

19 Nozzles
19 Boquillas
Ø 16-34 mm / 0.63"-1.34"

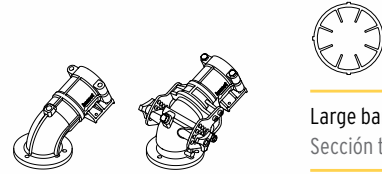

Large barrel cross section
Sección transversal del tubo grande

Fixed Trajectory 24° / 21°
Trayectoria fija 24° / 21°

Variable Trajectory 15° -45°
Trayectoria regulable 15° - 45°

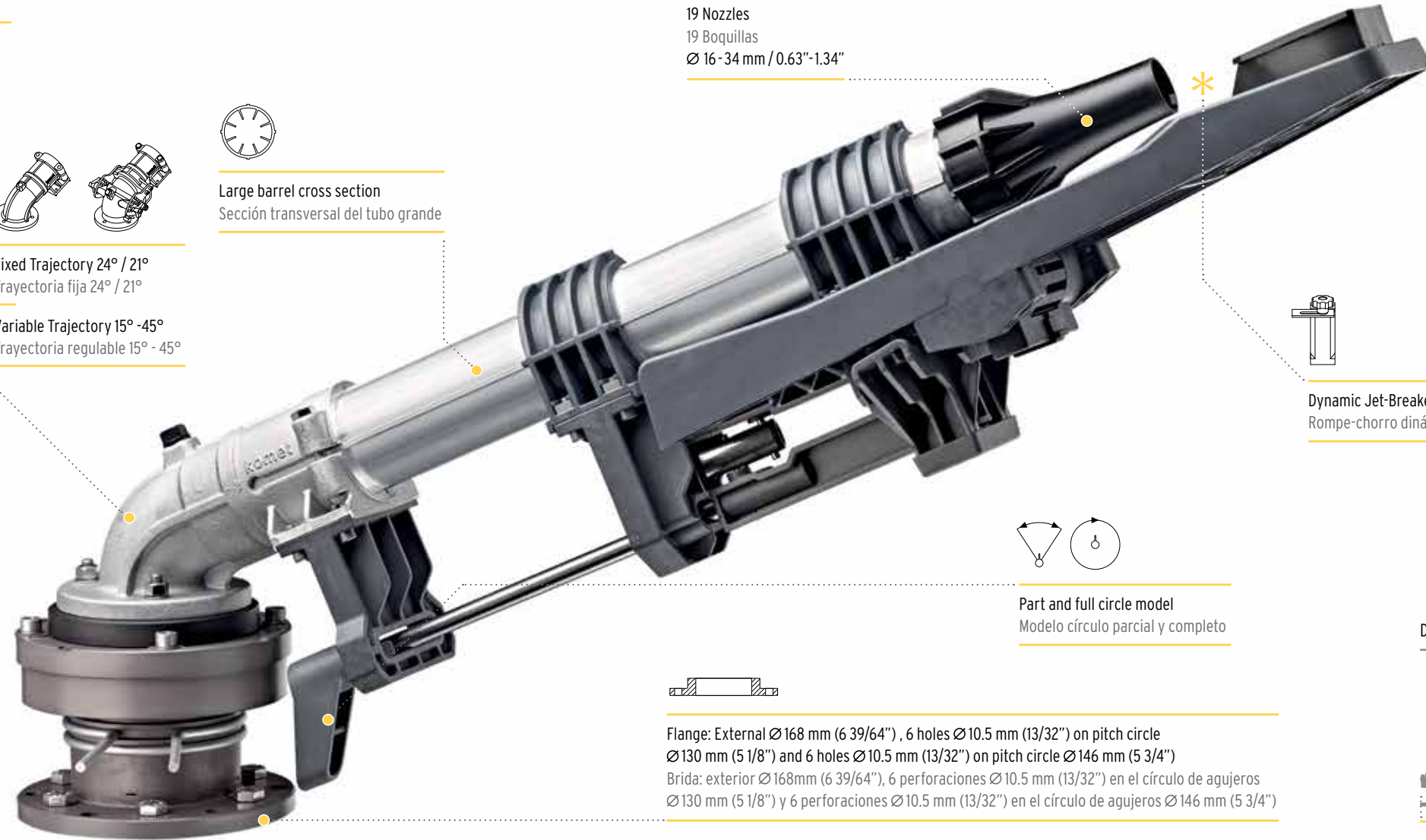

Dynamic Jet-Breaker (Optional)
Rompe-chorro dinámico (Opcional)

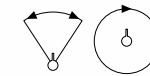

Part and full circle model
Modelo círculo parcial y completo

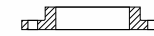

Flange: External Ø168 mm (6 39/64"), 6 holes Ø10.5 mm (13/32") on pitch circle Ø130 mm (5 1/8") and 6 holes Ø10.5 mm (13/32") on pitch circle Ø146 mm (5 3/4")
Brida: exterior Ø168mm (6 39/64"), 6 perforaciones Ø10.5 mm (13/32") en el círculo de agujeros Ø130 mm (5 1/8") y 6 perforaciones Ø10.5 mm (13/32") en el círculo de agujeros Ø146 mm (5 3/4")

Dimensions / Medidas **24°**

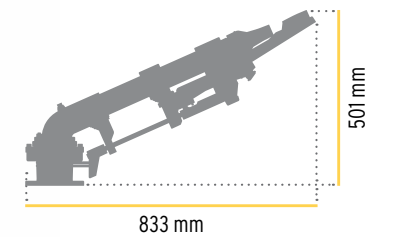

komet | Twin 140 ULTRA

Pressure Presión	Nozzle / Boquilla 16 mm - 0.63"		Nozzle / Boquilla 18 mm - 0.71"		Nozzle / Boquilla 20 mm - 0.79"	
	Flow Caudal m³/h	Radius Radio m	Flow Caudal m³/h	Radius Radio m	Flow Caudal m³/h	Radius Radio m
2,0	13,8	29,0	17,5	29,3	21,7	29,5
2,5	15,4	32,3	19,5	33,4	24,2	34,6
3,0	16,9	35,5	21,4	37,6	26,5	39,7
3,5	18,2	36,5	23,1	38,6	28,7	40,8
4,0	19,5	37,5	24,7	39,7	30,7	41,8
4,5	20,7	38,7	26,2	41,1	32,5	43,5
5,0	21,8	40,0	27,6	42,6	34,3	45,1
5,5	22,9	41,3	29,0	43,9	35,9	46,5
6,0	23,9	42,6	30,3	45,3	37,5	48,0
6,5	24,9	43,5	31,5	46,2	39,1	48,9
7,0	25,8	44,4	32,7	47,2	40,6	49,9

P.S. The performance data were obtained under ideal testing conditions and may be adversely affected by wind and other factors. Pressure refers to pressure at nozzle. A lowered trajectory angle improves the irrigation efficiency in windy conditions. For every 3° drop of the trajectory angle the throw is reduced by approx. 3 to 4%.
Los datos indicados en la tabla se refieren a condiciones de calma y pueden ser influenciados negativamente por viento u otros factores. La presión efectiva indicada se refiere a la presión de la boquilla. El bajar el ángulo de la trayectoria, ayuda a mejorar la eficacia del riego en condiciones de viento. Por cada 3° que se baje el ángulo de trayectoria, el alcance del chorro se reduce aproximadamente entre un 3 y un 4 %

High Performance Nozzles / Boquillas de alto rendimiento Trajectory angle / Angulo de trayectoria **24°**

Nozzle / Boquilla 22 mm - 0.87"		Nozzle / Boquilla 24 mm - 0.94"		Nozzle / Boquilla 26 mm - 1.02"		Nozzle / Boquilla 28 mm - 1.10"		Nozzle / Boquilla 30 mm - 1.18"		Nozzle / Boquilla 32 mm - 1.26"		Nozzle / Boquilla 34 mm - 1.34"	
Flow Caudal m³/h	Radius Radio m	Flow Caudal m³/h	Radius Radio m	Flow Caudal m³/h	Radius Radio m	Flow Caudal m³/h	Radius Radio m	Flow Caudal m³/h	Radius Radio m	Flow Caudal m³/h	Radius Radio m	Flow Caudal m³/h	Radius Radio m
26,1	30,0	31,1	30,4	36,7	30,7	42,3	31,0	48,6	31,3	55,7	31,7	62,5	32,0
29,2	35,4	34,7	36,1	41,0	36,4	47,3	36,7	54,3	37,0	62,3	37,3	69,8	37,6
31,9	40,8	38,0	41,8	44,9	42,1	51,8	42,3	59,5	42,6	68,2	42,9	76,5	43,3
34,5	42,3	41,1	43,8	48,5	45,0	56,0	46,1	64,3	47,0	73,7	47,8	82,6	48,9
36,9	43,8	43,9	45,7	51,8	47,8	59,8	50,0	68,7	51,3	78,8	52,7	88,3	54,6
39,1	45,6	46,6	47,6	55,0	50,0	63,5	52,3	72,9	54,1	83,6	56,0	93,7	57,9
41,2	47,3	49,1	49,5	58,0	52,1	66,9	54,6	76,8	56,9	88,1	59,3	98,7	61,3
43,2	48,8	51,5	51,1	60,8	53,8	70,2	56,5	80,5	58,9	92,4	61,2	103,6	63,5
45,2	50,3	53,8	52,7	63,5	55,6	73,3	58,4	84,1	60,8	96,5	63,2	108,2	65,7
47,0	51,4	56,0	53,9	66,1	56,8	76,3	59,6	87,6	62,1	100,4	64,5	112,6	67,2
48,8	52,5	58,1	55,2	68,6	58,0	79,2	60,9	90,9	63,3	104,2	65,8	116,8	68,7

komet | Twin 160 ULTRA

Available Models / Modelos disponibles

Twin 160

24° / 21°



Twin 160

VARI ANGLE

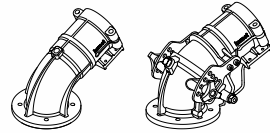

Fixed Trajectory 24° / 21°
Trayectoria fija 24° / 21°

Variable Trajectory 15° - 45°
Trayectoria regulable 15° - 45°



Large barrel cross section
Sección transversal del tubo grande

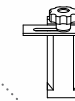
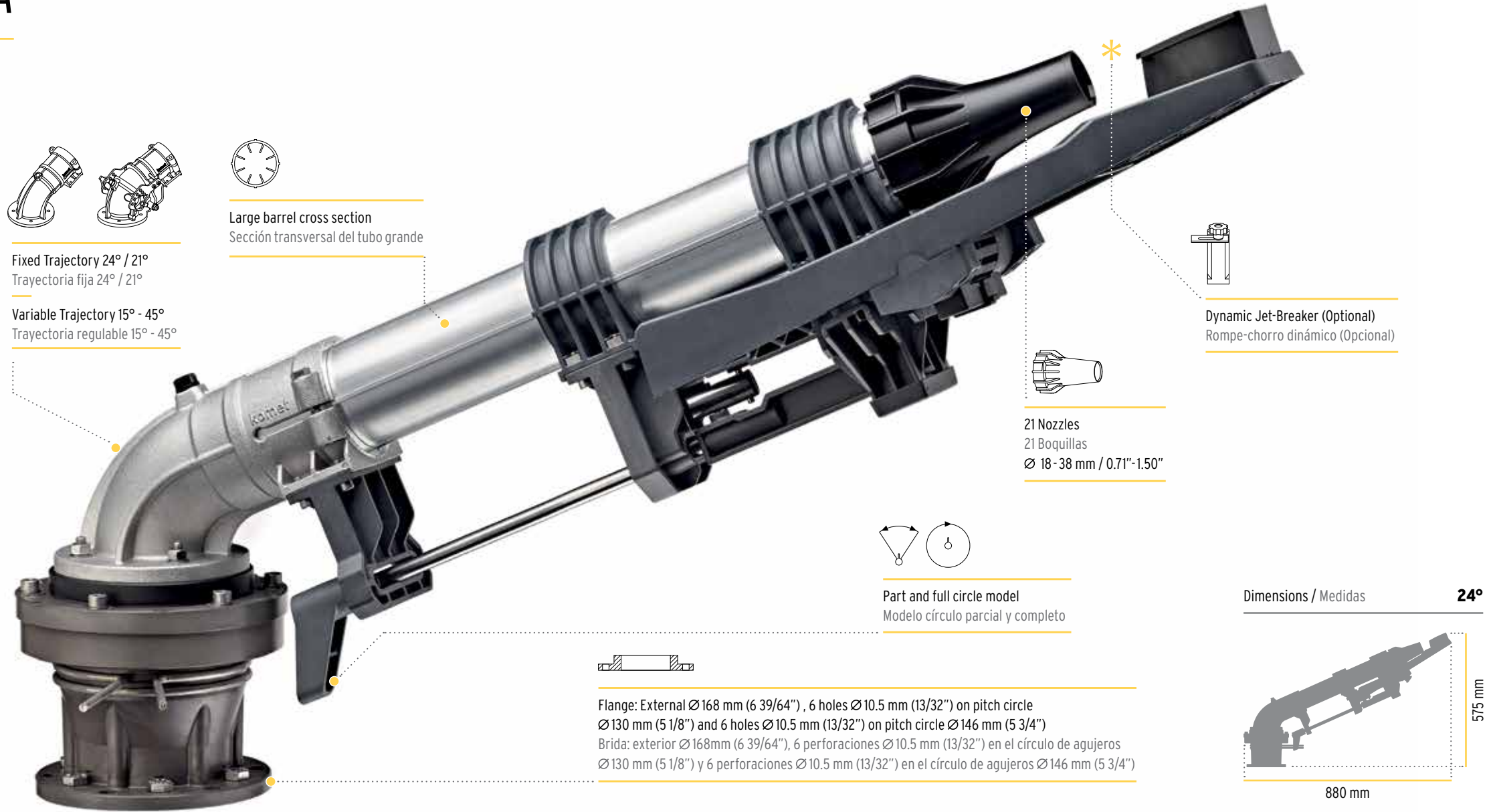

Dynamic Jet-Breaker (Optional)
Rompe-chorro dinámico (Opcional)

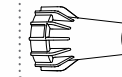

21 Nozzles
21 Boquillas
Ø 18 - 38 mm / 0.71" - 1.50"

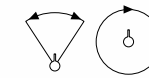

Part and full circle model
Modelo círculo parcial y completo

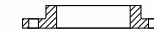

Flange: External Ø168 mm (6 39/64"), 6 holes Ø10.5 mm (13/32") on pitch circle Ø130 mm (5 1/8") and 6 holes Ø10.5 mm (13/32") on pitch circle Ø146 mm (5 3/4")
Brida: exterior Ø168mm (6 39/64"), 6 perforaciones Ø10.5 mm (13/32") en el círculo de agujeros Ø130 mm (5 1/8") y 6 perforaciones Ø10.5 mm (13/32") en el círculo de agujeros Ø146 mm (5 3/4")

Dimensions / Medidas **24°**

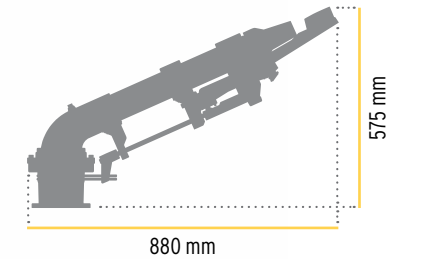

komet | Twin 160 ULTRA

Pressure Presión	Nozzle / Boquilla 18 mm - 0.71"		Nozzle / Boquilla 20 mm - 0.79"		Nozzle / Boquilla 22 mm - 0.87"		Nozzle / Boquilla 24 mm - 0.94"	
	Flow Caudal m³/h	Radius Radio m	Flow Caudal m³/h	Radius Radio m	Flow Caudal m³/h	Radius Radio m	Flow Caudal m³/h	Radius Radio m
3,0	21,7	37,8	26,9	39,9	32,4	41,0	38,5	42,0
3,5	23,4	39,4	29,0	41,6	34,9	43,1	41,6	44,6
4,0	25,1	41,0	31,0	43,2	37,4	45,3	44,5	47,3
4,5	26,6	42,3	32,9	44,7	39,6	46,9	47,2	49,0
5,0	28,0	43,6	34,7	46,2	41,8	48,5	49,7	50,8
5,5	29,4	44,7	36,4	47,3	43,8	49,7	52,1	52,0
6,0	30,7	45,7	38,0	48,4	45,8	50,9	54,4	53,3
6,5	31,9	46,7	39,5	49,4	47,6	52,0	56,7	54,5
7,0	33,2	47,7	41,0	50,4	49,4	53,1	58,8	55,7
7,5	34,3	48,5	42,5	51,4	51,2	54,1	60,9	56,8
8,0	35,4	49,3	43,9	52,3	52,8	55,1	62,9	57,9
8,5	36,5	50,2	45,2	53,2	54,5	56,0	64,8	58,9
9,0	37,6	51,0	46,5	54,1	56,0	57,0	66,7	59,9

PS. The performance data were obtained under ideal testing conditions and may be adversely affected by wind and other factors. Pressure refers to pressure at nozzle. A lowered trajectory angle improves the irrigation efficiency in windy conditions. For every 3° drop of the trajectory angle the throw is reduced by approx. 3 to 4%.
Los datos indicados en la tabla se refieren a condiciones de calma y pueden ser influenciados negativamente por viento u otros factores. La presión efectiva indicada se refiere a la presión de la boquilla. El bajar el ángulo de la trayectoria, ayuda a mejorar la eficacia del riego en condiciones de viento. Por cada 3° que se baje el ángulo de trayectoria, el alcance del chorro se reduce aproximadamente entre un 3 y un 4 %

High Performance Nozzles / Boquillas de alto rendimiento Trajectory angle / Angulo de trayectoria **24°**

Nozzle / Boquilla 26 mm - 1.02"		Nozzle / Boquilla 28 mm - 1.10"		Nozzle / Boquilla 30 mm - 1.18"		Nozzle / Boquilla 32 mm - 1.26"		Nozzle / Boquilla 34 mm - 1.34"		Nozzle / Boquilla 36 mm - 1.42"		Nozzle / Boquilla 38 mm - 1.50"	
Flow Caudal m³/h	Radius Radio m	Flow Caudal m³/h	Radius Radio m	Flow Caudal m³/h	Radius Radio m	Flow Caudal m³/h	Radius Radio m	Flow Caudal m³/h	Radius Radio m	Flow Caudal m³/h	Radius Radio m	Flow Caudal m³/h	Radius Radio m
45,6	42,3	52,6	42,5	60,4	42,8	69,1	43,2	77,5	43,5	86,8	43,8	97,0	44,1
49,2	45,9	56,8	47,1	65,2	48,0	74,6	48,8	83,7	50,0	93,7	51,1	104,7	52,1
52,6	49,5	60,7	51,7	69,7	53,1	79,8	54,5	89,4	56,5	100,2	58,3	112,0	60,2
55,8	51,4	64,4	53,8	74,0	55,7	84,6	57,6	94,9	59,6	106,3	61,6	118,8	63,6
58,8	53,4	67,9	55,9	78,0	58,3	89,2	60,8	100,0	62,8	112,0	64,9	125,2	67,0
61,7	54,7	71,2	57,5	81,8	59,9	93,5	62,3	104,9	64,6	117,5	66,9	131,3	69,2
64,4	56,1	74,4	59,0	85,4	61,4	97,7	63,8	109,5	66,3	122,7	68,8	137,1	71,4
67,1	57,4	77,4	60,2	88,9	62,7	101,7	65,1	114,0	67,9	127,7	70,6	142,7	73,2
69,6	58,6	80,3	61,5	92,2	64,0	105,5	66,5	118,3	69,4	132,5	72,3	148,1	75,1
72,0	59,7	83,1	62,5	95,5	65,0	109,2	67,5	122,5	70,6	137,2	73,6	153,3	76,6
74,4	60,7	85,9	63,6	98,6	66,1	112,8	68,6	126,5	71,8	141,7	74,9	158,3	78,0
76,7	61,7	88,5	64,4	101,6	66,9	116,3	69,4	130,4	72,7	146,0	75,8	163,2	78,9
78,9	62,6	91,1	65,3	104,6	67,8	119,6	70,3	134,2	73,5	150,3	76,7	168,0	79,8

komet | Twin 202 ULTRA

Available Models / Modelos disponibles

Twin 202

24°



Twin 202

VARI ANGLE

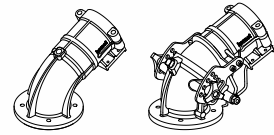

Fixed Trajectory 24°
Trayectoria fija 24°

Variable Trajectory 15° - 45°
Trayectoria regulable 15° - 45°



Large barrel cross section
Sección transversal del tubo grande

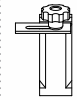
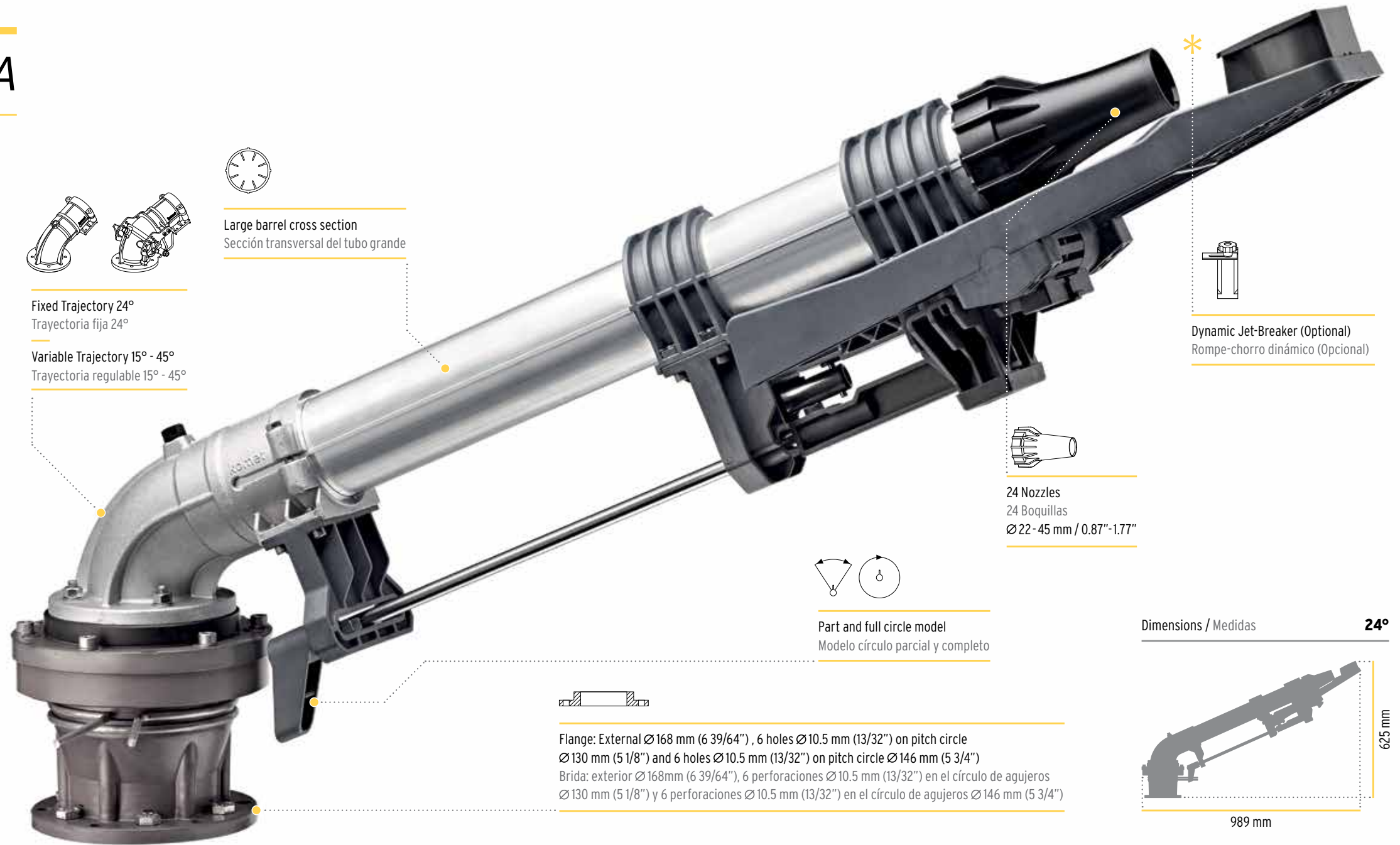

Dynamic Jet-Breaker (Optional)
Rompe-chorro dinámico (Opcional)

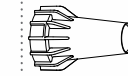

24 Nozzles
24 Boquillas
Ø22 - 45 mm / 0.87" - 1.77"

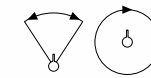

Part and full circle model
Modelo círculo parcial y completo

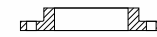

Flange: External Ø168 mm (6 3/4"), 6 holes Ø10.5 mm (13/32") on pitch circle Ø130 mm (5 1/8") and 6 holes Ø10.5 mm (13/32") on pitch circle Ø146 mm (5 3/4")
Brida: exterior Ø168mm (6 3/4"), 6 perforaciones Ø10.5 mm (13/32") en el círculo de agujeros Ø130 mm (5 1/8") y 6 perforaciones Ø10.5 mm (13/32") en el círculo de agujeros Ø146 mm (5 3/4")

Dimensions / Medidas **24°**

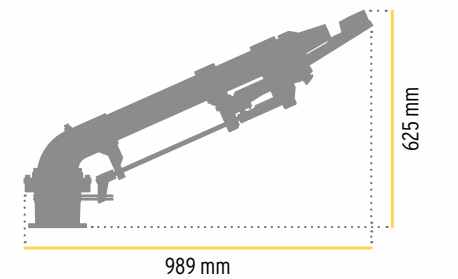

komet | Twin 202 ULTRA

Pressure Presión	Nozzle / Boquilla 22 mm - 0.87"		Nozzle / Boquilla 24 mm - 0.94"		Nozzle / Boquilla 26 mm - 1.02"		Nozzle / Boquilla 28 mm - 1.10"		Nozzle / Boquilla 30 mm - 1.18"	
	Flow Caudal m³/h	Radius Radio m	Flow Caudal m³/h	Radius Radio m	Flow Caudal m³/h	Radius Radio m	Flow Caudal m³/h	Radius Radio m	Flow Caudal m³/h	Radius Radio m
3,0	32,4	41,5	38,5	42,6	45,6	42,9	52,6	43,1	60,4	43,5
3,5	34,9	43,6	41,6	45,2	49,2	46,4	56,8	47,6	65,2	48,5
4,0	37,4	45,7	44,5	47,7	52,6	49,9	60,7	52,1	69,7	53,6
4,5	39,6	47,2	47,2	49,4	55,8	51,8	64,4	54,2	74,0	56,1
5,0	41,8	48,7	49,7	51,0	58,8	53,6	67,9	56,2	78,0	58,6
5,5	43,8	49,9	52,1	52,3	61,7	55,0	71,2	57,7	81,8	60,2
6,0	45,8	51,1	54,4	53,5	64,4	56,4	74,4	59,3	85,4	61,7
6,5	47,6	52,2	56,7	54,8	67,1	57,7	77,4	60,5	88,9	63,0
7,0	49,4	53,4	58,8	56,0	69,6	58,9	80,3	61,8	92,2	64,3
7,5	51,2	54,5	60,9	57,3	72,0	60,1	83,1	63,0	95,5	65,5
8,0	52,8	55,7	62,9	58,5	74,4	61,4	85,9	64,2	98,6	66,8
8,5	54,5	56,6	64,8	59,5	76,7	62,3	88,5	65,1	101,6	67,6
9,0	56,0	57,6	66,7	60,5	78,9	63,3	91,1	66,0	104,6	68,5

P.S. The performance data were obtained under ideal testing conditions and may be adversely affected by wind and other factors. Pressure refers to pressure at nozzle. A lowered trajectory angle improves the irrigation efficiency in windy conditions. For every 3° drop of the trajectory angle the throw is reduced by approx. 3 to 4%.
Los datos indicados en la tabla se refieren a condiciones de calma y pueden ser influenciados negativamente por viento u otros factores. La presión efectiva indicada se refiere a la presión de la boquilla. El bajar el ángulo de la trayectoria, ayuda a mejorar la eficacia del riego en condiciones de viento. Por cada 3° que se baje el ángulo de trayectoria, el alcance del chorro se reduce aproximadamente entre un 3 y un 4 %

High Performance Nozzles / Boquillas de alto rendimiento Trajectory angle / Angulo de trayectoria **24°**

Nozzle / Boquilla 32 mm - 1.26"		Nozzle / Boquilla 34 mm - 1.34"		Nozzle / Boquilla 36 mm - 1.42"		Nozzle / Boquilla 38 mm - 1.50"		Nozzle / Boquilla 40 mm - 1.57"		Nozzle / Boquilla 42 mm - 1.65"		Nozzle / Boquilla 44 mm - 1.73"		Nozzle / Boquilla 45 mm - 1.77"	
Flow Caudal m³/h	Radius Radio m	Flow Caudal m³/h	Radius Radio m	Flow Caudal m³/h	Radius Radio m	Flow Caudal m³/h	Radius Radio m	Flow Caudal m³/h	Radius Radio m	Flow Caudal m³/h	Radius Radio m	Flow Caudal m³/h	Radius Radio m	Flow Caudal m³/h	Radius Radio m
69,1	43,8	77,5	44,1	86,8	44,4	97,0	44,7	106,6	45,1	117,5	45,4	129,9	45,8	135,7	46,0
74,6	49,4	83,7	50,5	93,7	51,6	104,7	52,7	115,1	53,5	126,9	54,3	140,3	55,0	146,5	55,4
79,8	55,0	89,4	57,0	100,2	58,9	112,0	60,7	123,1	61,8	135,7	63,1	150,0	64,3	156,7	64,9
84,6	58,1	94,9	60,0	106,3	62,0	118,8	64,0	130,5	65,3	143,9	66,8	159,1	68,2	166,2	68,9
89,2	61,1	100,0	63,1	112,0	65,2	125,2	67,3	137,6	68,8	151,7	70,5	167,7	72,1	175,1	73,0
93,5	62,6	104,9	64,9	117,5	67,2	131,3	69,5	144,3	71,3	159,1	73,1	175,8	75,0	183,7	75,9
97,7	64,1	109,5	66,7	122,7	69,2	137,1	71,7	150,7	73,7	166,2	75,7	183,7	77,8	191,9	78,8
101,7	65,5	114,0	68,2	127,7	70,9	142,7	73,6	156,9	75,7	173,0	77,9	191,2	80,1	199,7	81,2
105,5	66,8	118,3	69,8	132,5	72,6	148,1	75,5	162,8	77,8	179,5	80,1	198,4	82,5	207,2	83,7
109,2	68,1	122,5	71,1	137,2	74,1	153,3	77,2	168,5	79,5	185,8	82,0	205,3	84,5	214,5	85,7
112,8	69,3	126,5	72,5	141,7	75,7	158,3	78,8	174,1	81,3	191,9	83,8	212,1	86,4	221,5	87,7
116,3	70,2	130,4	73,4	146,0	76,6	163,2	79,7	179,4	82,2	197,8	84,9	218,6	87,5	228,4	88,8
119,6	71,0	134,2	74,3	150,3	77,4	168,0	80,6	184,6	83,2	203,5	85,9	224,9	88,6	235,0	90,0

Performance Data U.S. Units
 Datos Técnicos U.S. Unidades

komet | *Twin Max* High Performance Nozzles / Boquillas alto rendimiento Trajectory angle / Angulo de trayectoria **24°**

PSI	Nozzle 0.39"		Nozzle 0.43"		Nozzle 0.47"		Nozzle 0.51"		Nozzle 0.55"		Nozzle 0.59"		Nozzle 0.63"		Nozzle 0.67"		Nozzle 0.71"		Nozzle 0.79"		Nozzle 0.87"		Nozzle 0.94"		
	GPM	DIA.	GPM	DIA.	GPM	DIA.	GPM	DIA.	GPM	DIA.	GPM	DIA.	GPM	DIA.	GPM	DIA.	GPM	DIA.	GPM	DIA.	GPM	DIA.	GPM	DIA.	GPM
25	22	135'	27	140'	32	147'	38	154'	44	163'	50	171'	57	178'	64	180'	72	181'	89	184'	107	187'	128	190'	
30	24	145'	29	152'	35	159'	41	167'	48	174'	55	182'	62	190'	70	191'	79	193'	97	196'	118	199'	140	201'	
35	26	155'	32	163'	38	171'	44	179'	51	186'	59	193'	67	200'	76	205'	85	209'	105	217'	127	220'	151	224'	
40	28	165'	34	174'	40	183'	47	190'	55	197'	63	204'	72	211'	81	218'	91	224'	112	237'	136	242'	162	246'	
45	30	175'	36	184'	43	194'	50	201'	58	207'	67	214'	76	221'	86	229'	97	236'	119	251'	144	257'	172	263'	
50	31	184'	38	194'	45	204'	53	211'	62	218'	71	225'	80	232'	91	240'	102	248'	126	264'	152	272'	181	280'	
55	33	191'	40	201'	47	210'	56	217'	65	225'	74	232'	84	239'	95	247'	107	255'	132	272'	159	282'	190	292'	
60	34	198'	42	207'	50	217'	58	224'	67	232'	77	239'	88	246'	99	255'	111	263'	138	281'	166	292'	198	303'	
65	36	202'	43	212'	52	221'	61	229'	70	236'	81	244'	92	252'	103	260'	116	269'	143	286'	173	298'	206	311'	
70	37	207'	45	216'	54	225'	63	233'	73	241'	84	249'	95	257'	107	266'	120	275'	149	292'	180	305'	214	318'	
80	40	216'	48	225'	57	233'	67	242'	78	251'	89	260'	102	269'	115	277'	129	286'	159	304'	192	318'	229	333'	
90	42	225'	51	233'	61	241'	71	251'	83	261'	95	270'	108	280'	122	288'	137	297'	169	315'	204	330'	243	346'	
100	44	231'	54	240'	64	248'	75	258'	87	268'	100	278'	114	288'	128	296'	144	305'	178	323'	215	340'	256	357'	
110	47	235'	56	245'	67	255'	79	265'	91	274'	105	284'	119	293'	135	303'	151	312'	186	330'	225	348'	268	366'	

komet | *Twin 101 ULTRA* High Performance Nozzles / Boquillas alto rendimiento Trajectory angle / Angulo de trayectoria **24°**

PSI	Nozzle 0.47"		Nozzle 0.55"		Nozzle 0.63"		Nozzle 0.71"		Nozzle 0.79"		Nozzle 0.87"		Nozzle 0.94"		Nozzle 1.02"		Nozzle 1.10"	
	GPM	DIA.	GPM	DIA.	GPM	DIA.	GPM	DIA.	GPM	DIA.	GPM	DIA.	GPM	DIA.	GPM	DIA.	GPM	DIA.
30	35	161'	48	176'	62	192'	78	195'	97	198'	117	201'	139	203'	164	206'	189	208'
40	40	185'	55	200'	71	214'	90	227'	112	240'	135	244'	161	249'	190	254'	219	260'
50	45	205'	62	219'	80	233'	101	249'	125	266'	151	274'	180	282'	212	292'	245	302'
60	50	218'	67	233'	87	247'	111	265'	137	282'	165	293'	197	304'	232	318'	268	331'
70	54	226'	73	242'	94	258'	119	276'	148	294'	178	307'	212	320'	251	336'	289	352'
80	57	235'	78	252'	101	270'	128	288'	158	305'	191	320'	227	334'	268	352'	309	370'
90	61	243'	83	262'	107	281'	135	299'	168	316'	202	332'	241	348'	284	367'	328	385'
100	64	250'	87	269'	113	289'	143	307'	177	325'	213	342'	254	359'	300	377'	346	396'
110	67	256'	91	276'	118	295'	150	313'	186	332'	224	350'	266	368'	314	386'	363	404'

komet | *Twin 140 ULTRA* High Performance Nozzles / Boquillas alto rendimiento Trajectory angle / Angulo de trayectoria **24°**

PSI	Nozzle 0.63"		Nozzle 0.71"		Nozzle 0.79"		Nozzle 0.87"		Nozzle 0.94"		Nozzle 1.02"		Nozzle 1.10"		Nozzle 1.18"		Nozzle 1.26"		Nozzle 1.34"	
	GPM	DIA.	GPM	DIA.	GPM	DIA.	GPM	DIA.	GPM	DIA.	GPM	DIA.	GPM	DIA.	GPM	DIA.	GPM	DIA.	GPM	DIA.
30	62	192'	78	196'	97	199'	117	202'	139	204'	164	207'	189	209'	217	211'	249	213'	280	215'
40	71	215'	90	228'	112	241'	135	246'	161	250'	190	256'	219	261'	251	266'	288	270'	323	273'
50	80	234'	101	251'	125	267'	151	275'	180	284'	212	294'	245	304'	281	311'	322	318'	361	324'
60	87	248'	111	266'	137	283'	165	295'	197	306'	232	319'	268	333'	308	343'	353	354'	395	363'
70	94	260'	119	277'	148	295'	178	308'	212	321'	251	337'	289	353'	332	367'	381	381'	427	393'
80	101	271'	128	289'	158	307'	191	321'	227	336'	268	354'	309	372'	355	387'	407	402'	457	417'
90	107	282'	135	300'	168	318'	202	334'	241	350'	284	369'	328	387'	377	403'	432	419'	484	436'
100	113	290'	143	308'	177	326'	213	343'	254	360'	300	379'	346	398'	397	414'	455	430'	511	449'
110	118	296'	150	315'	186	334'	224	352'	266	369'	314	388'	363	406'	416	423'	478	439'	535	459'

P.S. The performance data were obtained under ideal testing conditions and may be adversely affected by wind and other factors. Pressure refers to pressure at nozzle. A lowered trajectory angle improves the irrigation efficiency in windy conditions. For every 3° drop of the trajectory angle the throw is reduced by approx. 3 to 4%. Los datos indicados en la tabla se refieren a condiciones de calma y pueden ser influenciados negativamente por viento u otros factores. La presión efectiva indicada se refiere a la presión de la boquilla. El bajar el ángulo de la trayectoria, ayuda a mejorar la eficacia del riego en condiciones de viento. Por cada 3° que se baje el ángulo de trayectoria, el alcance del chorro se reduce aproximadamente entre un 3 y un 4%.

Performance Data U.S. Units
 Datos Técnicos U.S. Unidades

komet | *Twin 160 ULTRA* High Performance Nozzles / Boquillas alto rendimiento Trajectory angle / Angulo de trayectoria **24°**

PSI	Nozzle 0.71"		Nozzle 0.79"		Nozzle 0.87"		Nozzle 0.94"		Nozzle 1.02"		Nozzle 1.10"		Nozzle 1.18"		Nozzle 1.26"		Nozzle 1.34"		Nozzle 1.42"		Nozzle 1.50"	
	GPM	DIA.	GPM	DIA.	GPM	DIA.	GPM	DIA.	GPM	DIA.	GPM	DIA.	GPM	DIA.	GPM	DIA.	GPM	DIA.	GPM	DIA.	GPM	DIA.
40	92	227'	113	240'	137	244'	163	248'	192	254'	222	259'	255	264'	292	268'	327	271'	366	274'	409	277'
50	102	256'	127	273'	153	282'	182	290'	215	301'	248	311'	285	318'	326	325'	366	332'	409	338'	458	345'
60	112	275'	139	293'	167	305'	199	316'	235	330'	272	344'	312	355'	357	366'	400	376'	449	386'	501	397'
70	121	285'	150	303'	181	317'	215	330'	254	347'	294	363'	337	377'	386	391'	433	404'	484	417'	541	431'
80	130	294'	160	312'	193	327'	230	341'	272	360'	314	378'	360	393'	412	409'	462	424'	518	439'	579	454'
90	137	303'	170	321'	205	337'	244	353'	288	372'	333	391'	382	407'	437	423'	490	440'	549	456'	614	473'
100	145	311'	179	330'	216	347'	257	364'	304	383'	351	402'	403	418'	461	434'	517	453'	579	472'	647	490'
110	152	319'	188	338'	226	356'	270	374'	319	393'	368	412'	423	428'	484	445'	542	465'	607	485'	679	505'
120	159	326'	196	346'	237	365'	281	384'	333	402'	384	420'	441	437'	505	453'	566	475'	634	495'	709	516'
130	165	334'	204	354'	246	373'	293	393'	347	410'	400	428'	460	445'	526	461'	589	482'	660	503'	738	523'

komet | *Twin 202 ULTRA* High Performance Nozzles / Boquillas alto rendimiento Trajectory angle / Angulo de trayectoria **24°**

PSI	Nozzle 0.87"		Nozzle 0.94"		Nozzle 1.02"		Nozzle 1.10"		Nozzle 1.18"		Nozzle 1.26"		Nozzle 1.34"		Nozzle 1.42"		Nozzle 1.50"		Nozzle 1.57"		Nozzle 1.65"		Nozzle 1.73"		Nozzle 1.77"		
	GPM	DIA.	GPM	DIA.	GPM	DIA.	GPM	DIA.	GPM	DIA.	GPM	DIA.	GPM	DIA.	GPM	DIA.	GPM	DIA.	GPM	DIA.	GPM	DIA.	GPM	DIA.	GPM	DIA.	GPM
40	137	247'	163	252'	192	257'	222	263'	255	267'	292	271'	327	274'	366	278'	409	281'	450	283'	496	285'	548	288'	573	290'	
50	153	285'	182	294'	215	304'	248	315'	285	322'	326	330'	366	336'	409	343'	458	349'	503	354'	555	358'	613	363'	640	362'	
60	167	307'	199	319'	235	333'	272	347'	312	358'	357	369'	400	379'	449	389'	501	400'	551	407'	608	415'	671	422'	701	424'	
70	181	319'	215	332'	254	349'	294	365'	337	379'	386	393'	433	406'	484	420'	541	433'	595	443'	656	453'	725	464'	758	469'	
80	193	328'	230	343'	272	361'	314	380'	360	395'	412	411'	462	426'	518	441'	579	456'	636	468'	702	481'	775	493'	810	499'	
90	205	338'	244	355'	288	374'	333	393'	382	409'	437	425'	490	442'	549	459'	614	475'	675	489'	744	503'	822	517'	859	523'	
100	216	349'	257	366'	304	385'	351	404'	403	420'	461	437'	517	456'	579	474'	647	493'	711	508'	784	523'	867	538'	905	546'	
110	226	359'	270	377'	319	396'	368	415'	423	431'	484	448'	542	469'	607	489'	679	509'	746	524'	823	541'	909	557'	950	565'	
120	237	369'	281	388'	333	407'	384	425'	441	442'	505	459'	566	480'	634	501'	709	522'	779	538'	859	555'	950	572'	992	581'	
130	246	377'	293	397'	347	415'	400	433'	460	449'	526	466'	589	487'	660	508'	738	529'	811</								

Product Configuration
Gama de Modelos



Twin Max

PIVOT 18°

Fixed trajectory 18°
Trayectoria fija 18°

12 Performance taper bore nozzles
12 Boquillas de alto rendimiento
Ø 10 - 24 mm / 0.39"-0.94"

Part and full circle model
Modelo círculo parcial y completo

2" Thread
2" Rosca



Twin Max

PIVOT 12°

Fixed trajectory 12°
Trayectoria fija 12°

12 Performance taper bore nozzles
12 Boquillas de alto rendimiento
Ø 10 - 24 mm / 0.39"-0.94"

Part and full circle model
Modelo círculo parcial y completo

2" Thread
2" Rosca



Twin Max

24°

Fixed trajectory 24°
Trayectoria fija 24°

12 Performance taper bore nozzles
12 Boquillas de alto rendimiento
Ø 10 - 24 mm / 0.39"-0.94"

Part and full circle model
Modelo círculo parcial y completo

2" Thread
2" Rosca



Twin 101 ULTRA

24° / 21°

Fixed trajectory 24° / 21°
Trayectoria fija 24° / 21°

17 Performance taper bore nozzles
17 Boquillas de alto rendimiento
Ø 12 - 28 mm / 0.47"-1.10"

Part and full circle model
Modelo círculo parcial y completo

Flange connection
2" Thread (Optional)
Conexión de brida
2" Rosca (Opcional)



Twin 101 ULTRA

VARI ANGLE

Adjustable trajectory 15° - 45°
Trayectoria regulable 15° - 45°

17 Performance taper bore nozzles
17 Boquillas de alto rendimiento
Ø 12 - 28 mm / 0.47"-1.10"

Part and full circle model
Modelo círculo parcial y completo

Flange connection
2" Thread (Optional)
Conexión de brida
2" Rosca (Opcional)



Twin 101 ULTRA

PIVOT 18°

Fixed trajectory 18°
Trayectoria fija 18°

17 Performance taper bore nozzles
17 Boquillas de alto rendimiento
Ø 12 - 28 mm / 0.47"-1.10"

Part and full circle model
Modelo círculo parcial y completo

2" Thread
2" Rosca



Twin 101 ULTRA

FULL CIRCLE

Fixed trajectory 24°
Trayectoria fija 24°

17 Performance taper bore nozzles
17 Boquillas de alto rendimiento
Ø 12 - 28 mm / 0.47"-1.10"

Full circle model
Modelo círculo completo

Flange connection
2" Thread (Optional)
Conexión de brida
2" Rosca (Opcional)



Twin 140 ULTRA

24° / 21°

Fixed trajectory 24° / 21°
Trayectoria fija 24° / 21°

19 Performance taper bore nozzles
19 Boquillas de alto rendimiento
Ø 16 - 34 mm / 0.63"-1.34"

Part and full circle model
Modelo círculo parcial y completo

Flange connection
Conexión de brida



Twin 140 ULTRA

VARI ANGLE

Adjustable trajectory 15° - 45°
Trayectoria regulable 15° - 45°

19 Performance taper bore nozzles
19 Boquillas de alto rendimiento
Ø 16 - 34 mm / 0.63"-1.34"

Part and full circle model
Modelo círculo parcial y completo

Flange connection
Conexión de brida



Twin 160 ULTRA

24° / 21°

Fixed trajectory 24° / 21°
Trayectoria fija 24° / 21°

21 Performance taper bore nozzles
21 Boquillas de alto rendimiento
Ø 18 - 38 mm / 0.71"-1.50"

Part and full circle model
Modelo círculo parcial y completo

Flange connection
Conexión de brida



Twin 160 ULTRA

VARI ANGLE

Adjustable trajectory 15° - 45°
Trayectoria regulable 15° - 45°

21 Performance taper bore nozzles
21 Boquillas de alto rendimiento
Ø 18 - 38 mm / 0.71"-1.50"

Part and full circle model
Modelo círculo parcial y completo

Flange connection
Conexión de brida



Twin 160 ULTRA

FULL CIRCLE

Fixed trajectory 24°
Trayectoria fija 24°

21 Performance taper bore nozzles
21 Boquillas de alto rendimiento
Ø 18 - 38 mm / 0.71"-1.50"

Full circle model
Modelo círculo completo

Flange connection
Conexión de brida



Twin 202 ULTRA

24°

Fixed trajectory 24°
Trayectoria fija 24°

24 Performance taper bore nozzles
24 Boquillas de alto rendimiento
Ø 22 - 45 mm / 0.87"-1.77"

Part and full circle model
Modelo círculo parcial y completo

Flange connection
Conexión de brida



Twin 202 ULTRA

VARI ANGLE

Adjustable trajectory 15° - 45°
Trayectoria regulable 15° - 45°

24 Performance taper bore nozzles
24 Boquillas de alto rendimiento
Ø 22 - 45 mm / 0.87"-1.77"

Part and full circle model
Modelo círculo parcial y completo

Flange connection
Conexión de brida